

## CROSS-FIX

# CROSSFIX®

The new substructure system  
for rear-ventilated facades



Bringing it together.



## The rear-ventilated facade

Manifold, energy efficient and durable

**The rear-ventilated facade is undisputedly the most diverse of the facades. It scores with its long-lasting service, offers great design freedom and is extremely popular with architects.**

Contrary to other facade types no requirements are placed on rear-ventilated facades regarding the building statics, because it is only hung in front of the actual load-bearing wall. And exactly this decoupling of statics, thermal and weather protection is what enables architects and builders to have a very high design freedom and versatility.

### **Manifold construction possibilities**

The construction possibilities for exterior wall cladding are almost limitless. In addition to a wide range of possible raw materials for wall cladding, it is the colours in particular that give the building its character and individuality, visible from afar.

The rear-ventilated facade is equally suitable for new builds and restorations, in both public and private construction.

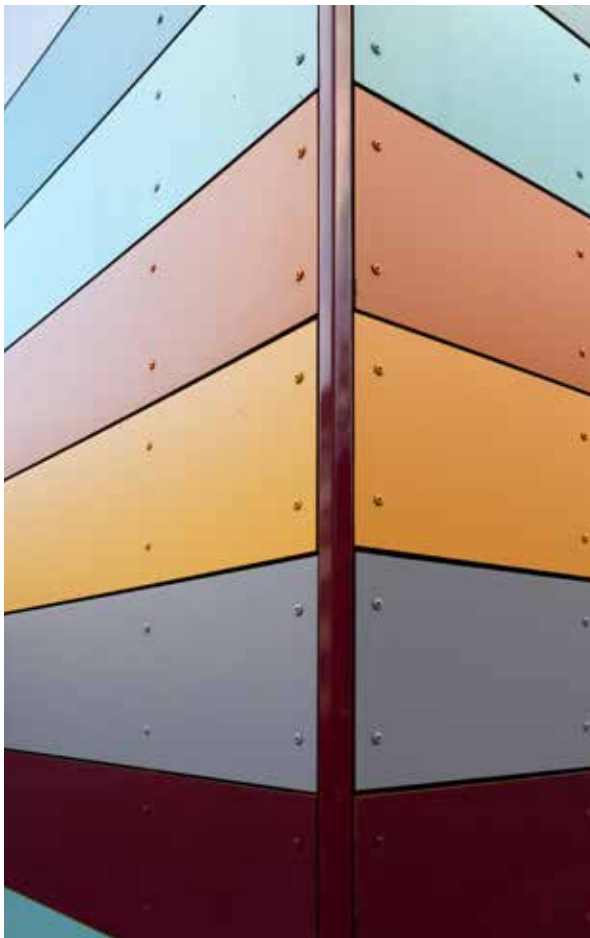

### **Of lasting value**

In addition to the design freedom, rear-ventilated facades also score in the areas of sustainability and economic efficiency, since it is one thing to plan and build a building. The other thing is the preservation of an intact function throughout the lifecycle and the proper handling of the used-up resources at the end of life. The individual components of the facade have a very long-lasting service and can be dismantled and returned to the material cycle at the end of their useful life. The use of nearly any insulation thickness and modern substructures enables U-values for the highest energy requirements.

### **Special fastening technology**

Every facade must be securely anchored to the load-bearing outer wall. In this case the substructure is the static link. The different fastening elements at this point are literally playing a key role, even though they seem to be insignificant. Because they ensure that all system components, such as insulation, substructure and facade cladding, are joined in a lasting and secure way.





## CROSSFIX® is the revolution in the market of rear-ventilated facades

### The new substructure system

CROSSFIX® is the first stainless steel substructure that can be used for horizontal and vertical support profiles. CROSSFIX® increases your flexibility, facilitates assembly, saves precious time and reduces your storage costs.

The CROSSFIX® console is made of stainless steel and thus significantly reduces the thermal bridge surcharge in the system.

With the CROSSFIX® modular system, EJOT delivers everything from a single supplier. In proven quality.

[www.ejot.com/crossfix-substructure-system](http://www.ejot.com/crossfix-substructure-system)



## All advantages at a glance

### > **Everything from one source**

EJOT supplies a complete substructure system for all applications and all necessary information for installation.

### > **All-purpose**

CROSSFIX® is the console for vertical and horizontal installation and offers maximum flexibility for all applications, "no matter if fixed-point or sliding-point installation"

### > **CROSSFIX® is flexible and easy to install**

Thanks to its high flexibility, CROSSFIX® enables quick and easy processing and, at the same time, standard-compliant fastening options on all common surfaces (e.g. concrete, solid and perforated brick, wood and steel substructures).

### > **CROSSFIX® has a low carbon footprint**

When manufacturing stainless steel, there is a more moderate amount of energy required and a considerably lower environmental pollution than when producing aluminum.

### > **CROSSFIX® has low thermal conductivity**

The CROSSFIX® console is made of A2/A4 stainless steel and thus enables a significant reduction in the thermal bridge surcharge compared to aluminum.

### > **Cost-efficient**

"CROSSFIX® enables considerable savings in material costs and storage costs."

### > **Fire protection**

The CROSSFIX® console is classified as non-flammable.

### > **CROSSFIX® is strong and reliable**

Stainless steel provides higher structural stability than aluminum, which means CROSSFIX® enables higher dead load capacities. In addition, a finite element analysis guarantees an optimised load distribution.

### > **CROSSFIX® is resilient to seismic activity**

Seismic tests confirm the dynamic load capacity of the CROSSFIX® console.

### > **CROSSFIX® withstands high temperature**

The thermal expansion of aluminum is twice as great as that of steel; the melting temperature of stainless steel is more than twice as high as that of aluminum.

### > **CROSSFIX® is an international certified system**

CROSSFIX® is ETA certified. This reduces the planning effort, creates cost security through clearly regulated calculation specifications and ensures more safety in the case of complaints or accidents. The CROSSFIX® console was also certified by the Passive House Institute.



**Vertical assembly**

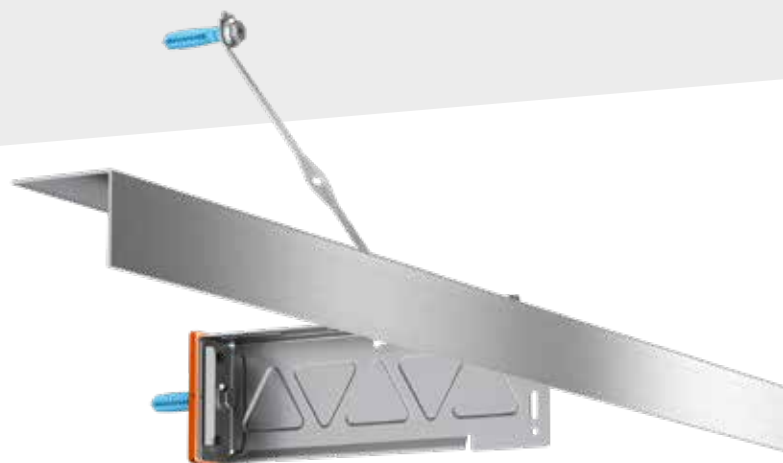

**Horizontal assembly**

# CROSSFIX® can be used universally

## A console for different assembly purposes

With the CROSSFIX® console, EJOT provides a flexible solution that can be used vertically and horizontally, no matter of whether it is a fixed point or sliding point

installation. This eliminates the need to install different consoles for vertical or horizontal use, which was previously the case.

## Vertical assembly

Fixed and sliding point design for vertically running support profiles

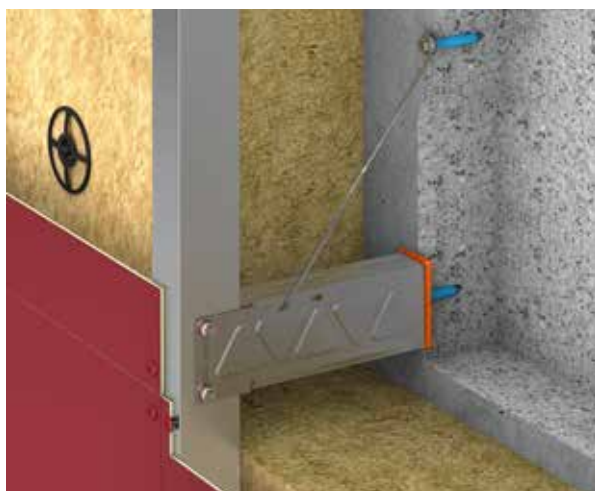

### Vertical fixed point

Fixing through clearance hole, optionally with powerkey for better load transmission

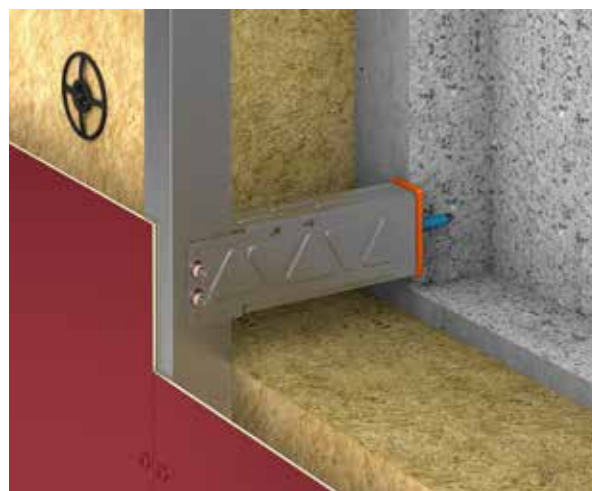

### Vertical sliding point

Fastening through slotted hole

## Horizontal assembly (two-layer application)

Fixed and sliding point design for horizontally running support profiles



### Horizontal fixed point

Fixing through clearance hole, optionally with powerkey for better load transmission

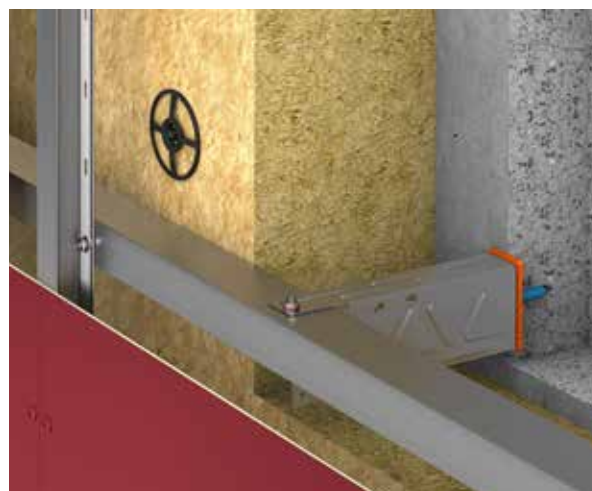

### Horizontal sliding point

Fastening through slotted hole

# CROSSFIX® increases energy efficiency

## Improved U-values thanks to stainless steel

In order to reduce thermal bridges in the rear ventilated facade system and thus to achieve higher energy efficiency, materials with the lowest possible thermal conductivity are recommended for facade substructures. While this is only approx. 17 W/(m²K) for stainless steel, it is approx. 160 W/(m²K) for aluminum.

Therefore, the use of stainless steel significantly reduces the transmission of thermal bridges in the CROSSFIX® substrate compared to systems made of solid aluminum. This means that significantly improved U-values can be achieved with the same insulation thickness.

## Aluminum and stainless steel in comparison

The isothermal images below illustrate temperature curves between the aluminum consoles and the CROSSFIX® consoles made of stainless steel.

This means that the wall inside can cool down considerably. The temperature difference between the indoor and outdoor area is therefore relatively small.

Lines of the same temperature are called isotherms. If these run almost parallel, there is only a slight disturbance compared to the one-dimensional heat flow (U-value, coefficient of heat transmission). The large thermal bridge, as can be seen in image 1, results in a large heat loss.

With the CROSSFIX® substructure system, compared to aluminum supports, only a minimal thermal bridge forms (image 2) and the wall in the interior cools significantly less. This example clearly shows how the use of a stainless steel substructure significantly increases energy efficiency.



**Image 1**  
Pronounced thermal bridge on aluminum consoles



**Image 2**  
Minimal thermal bridge with CROSSFIX®

# CROSSFIX® reduces costs

Improved U-values due to stainless steel

## Specification:

### Insulation thickness of 200 mm

The thermal conductivity of stainless steel is much lower than that of aluminum. Therefore, significantly improved U-values will be achieved with the same insulation thickness.

## Example:

<b>Reference object:</b>	<b>5 floors, 1800 m² facade area</b>
CROSSFIX® console:	K1 220 mm
Number of sliding points per m²:	2
Number of fixing points per m²:	1
Insulation thickness:	200 mm
Heating type:	natural gas

## Aluminum console

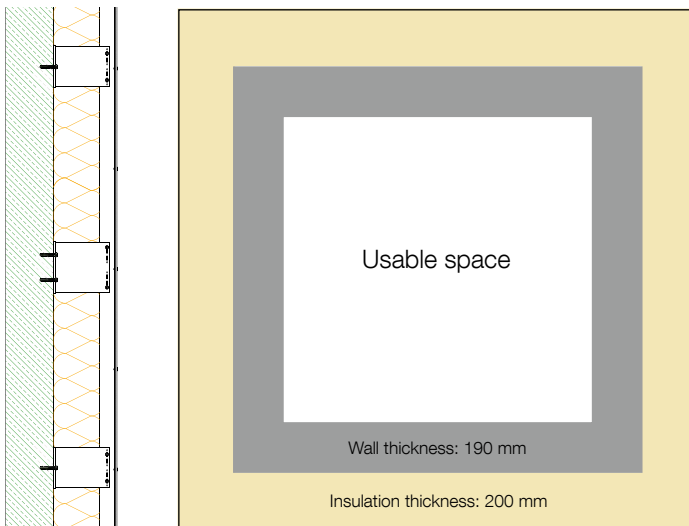

Facade U-value incl. thermal bridge  
= 0.251 W/m²K

## CROSSFIX® console

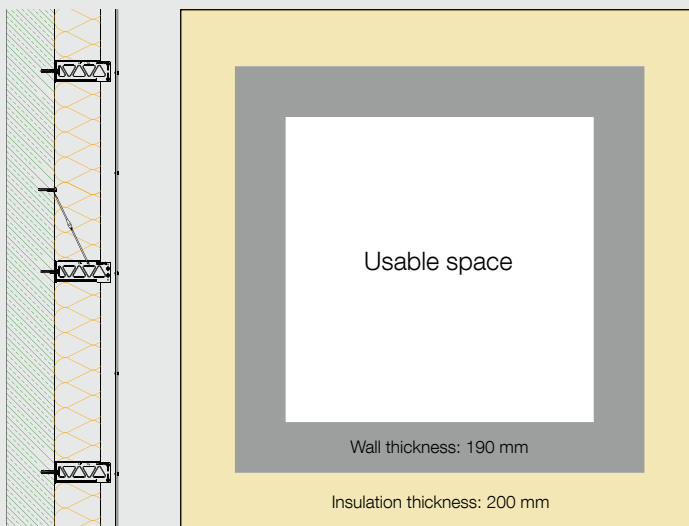

Facade U-value incl. thermal bridge  
**= 0.183 W/m²K**

Significantly lower U-value due to stainless steel

**After 10 years of use:**  
**48.6 t less CO<sub>2</sub> emission!**



# CROSSFIX® increases the useable space

More living space and usable space due to stainless steel

## Specification:

### U-value of 0.183 W/m²K is required to be achieved

The thermal conductivity of stainless steel is lower than that of aluminum. Therefore, the required U-value is achieved by CROSSFIX® with significantly lower insulation thickness than with an aluminum substructure.

## Example:

Reference object:	5 floors, 1800 m² facade area
CROSSFIX® console:	K1 220 mm
Number of sliding points per m²:	2
Number of fixing points per m²:	1

## Aluminum console

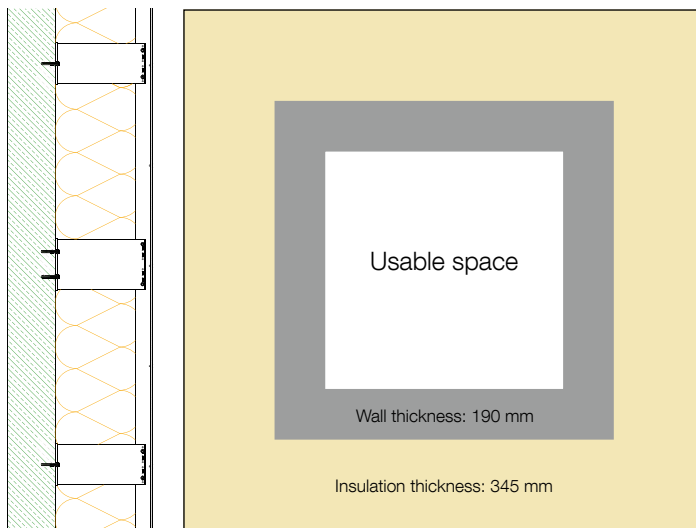

Insulation thickness: 345 mm  
 Facade U-value incl. thermal bridge  
 = 0.183 W/m²K

## CROSSFIX® console

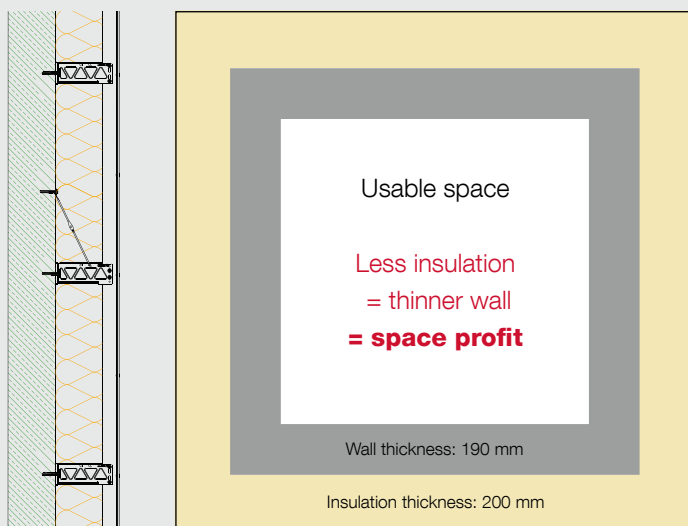

Insulation thickness: 200 mm  
 Facade U-value incl. thermal bridge  
 = 0.183 W/m²K

**Gain of space:**  
**96.45 m²**

# CROSSFIX® is a complete system

The individual components and the appropriate EJOT® accessories

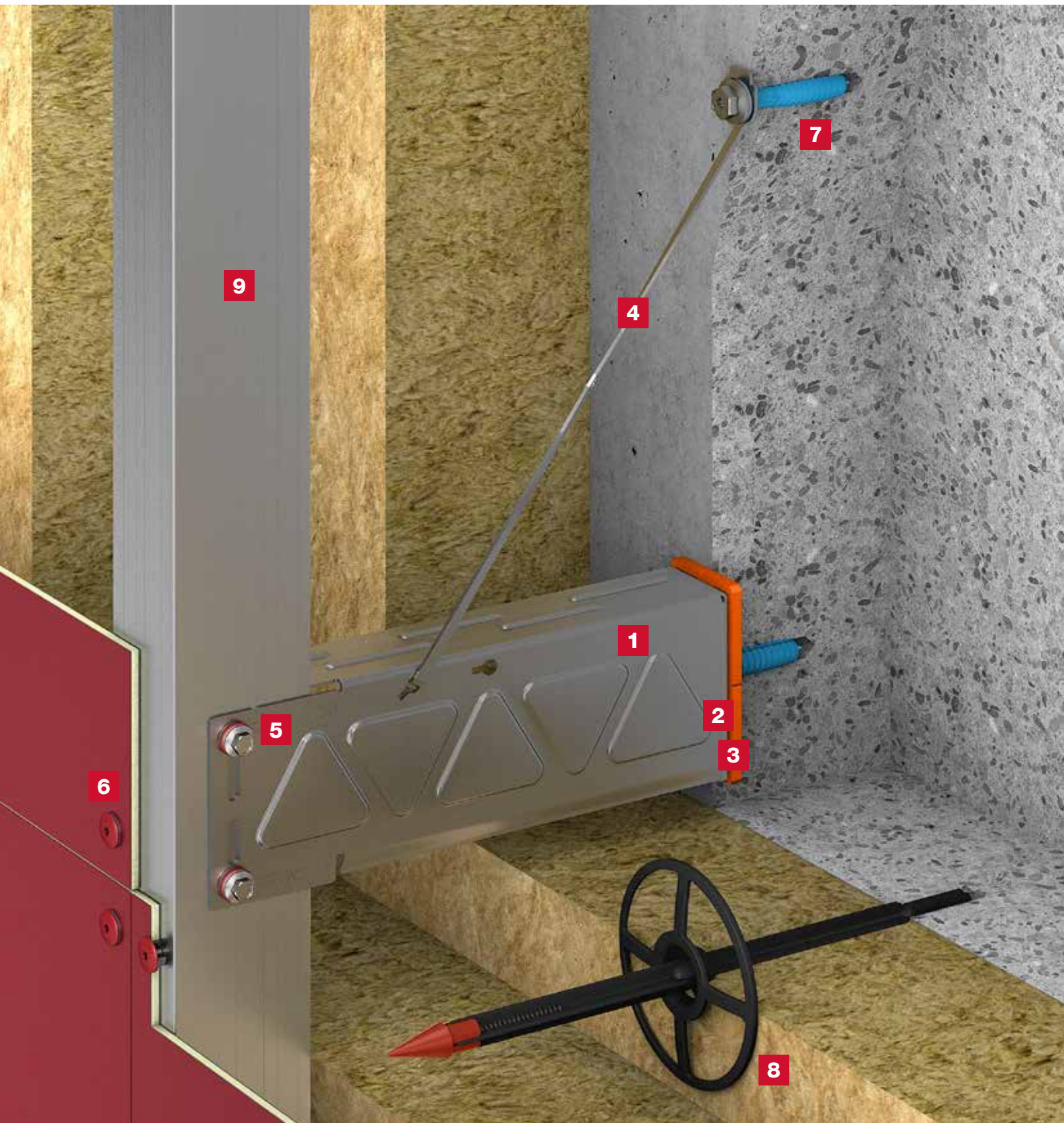

**1 Console**

Stainless steel (A2/A4). Reach 40-400 mm in 20-mm-steps, larger reach possible. Stress plate and thermal stop captive pre-assembled



**2 Stress plate**

For a higher load impact or load bearing capacity



**3 Thermal stop**

For even better U-values



**4 Powerkey**

For ideal load transmission



**5 Self-drilling screw VARIO**

Sliding and fixed point screw including sliding washer with buffer zone for connecting consoles and support profiles



**6 LT system**

Screws and centring grommets for fastening cladding panels to support profiles



**7 Anchoring**

Facade anchors, metal anchors or chemical anchors for fastening the consoles and support profiles in the load-bearing wall (depending on the structural requirements)



**8 Insulation support anchor**

For fixing insulating material



**9 Support profiles**

Support profiles in different versions for cladding panels



# CROSSFIX® system structure

## System depth

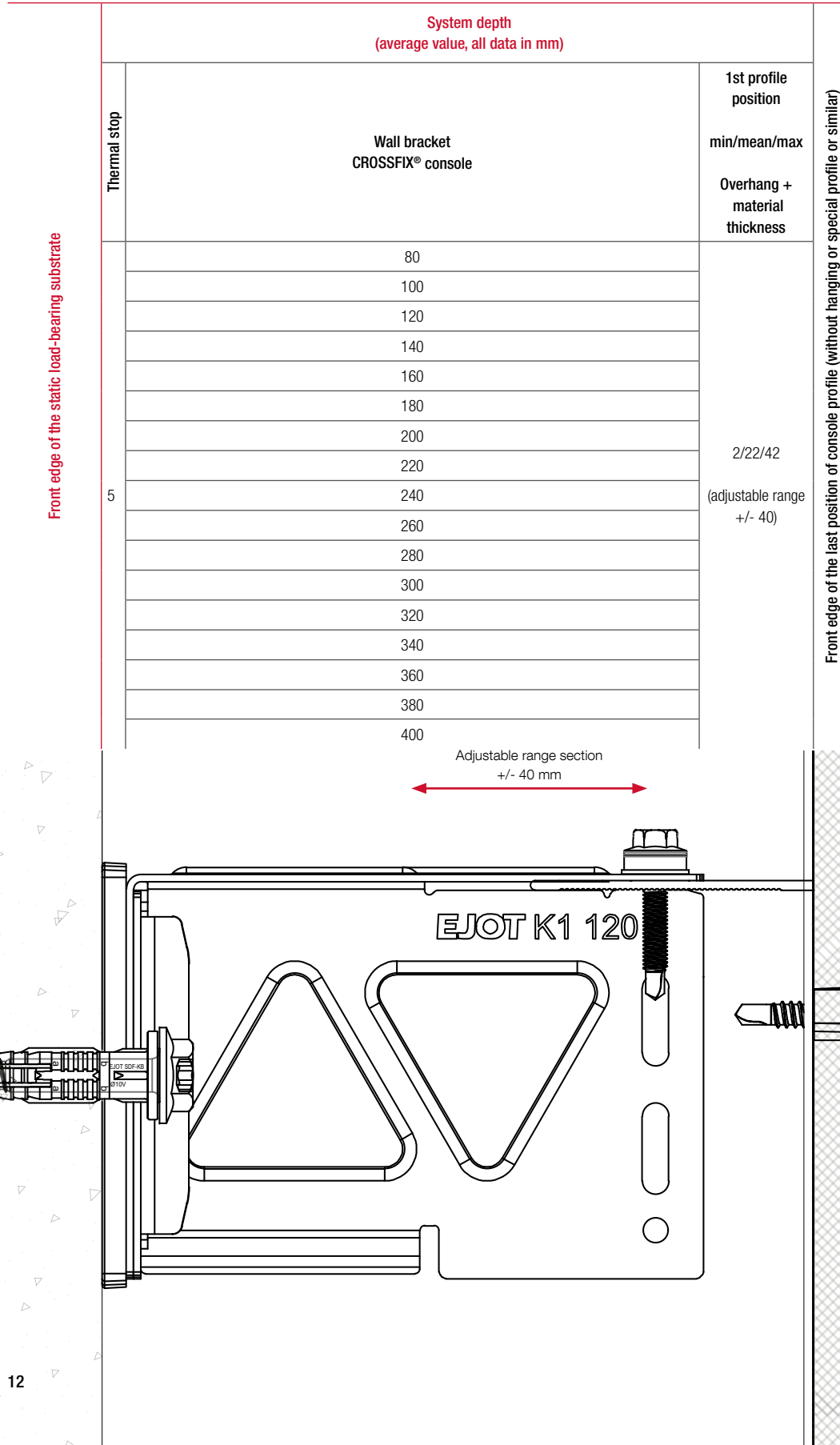

# Calculation example

## Standard system-depth console K1 with two-layer profile structure

### General information:

The relevance of the correctly selected system depth results from the definition of the insulation thickness and the requirements for the rear ventilation cross-section.

Furthermore, the choice of the correct system depth has an influence on the assembly of the support profiles.

System components	Depth [mm]
Thermal stop	5
Console K1	120
1st profile position, angle profile, horizontal	22
2nd profile position, Omega profile, vertical	27
<b>System depth total</b>	<b>174</b>

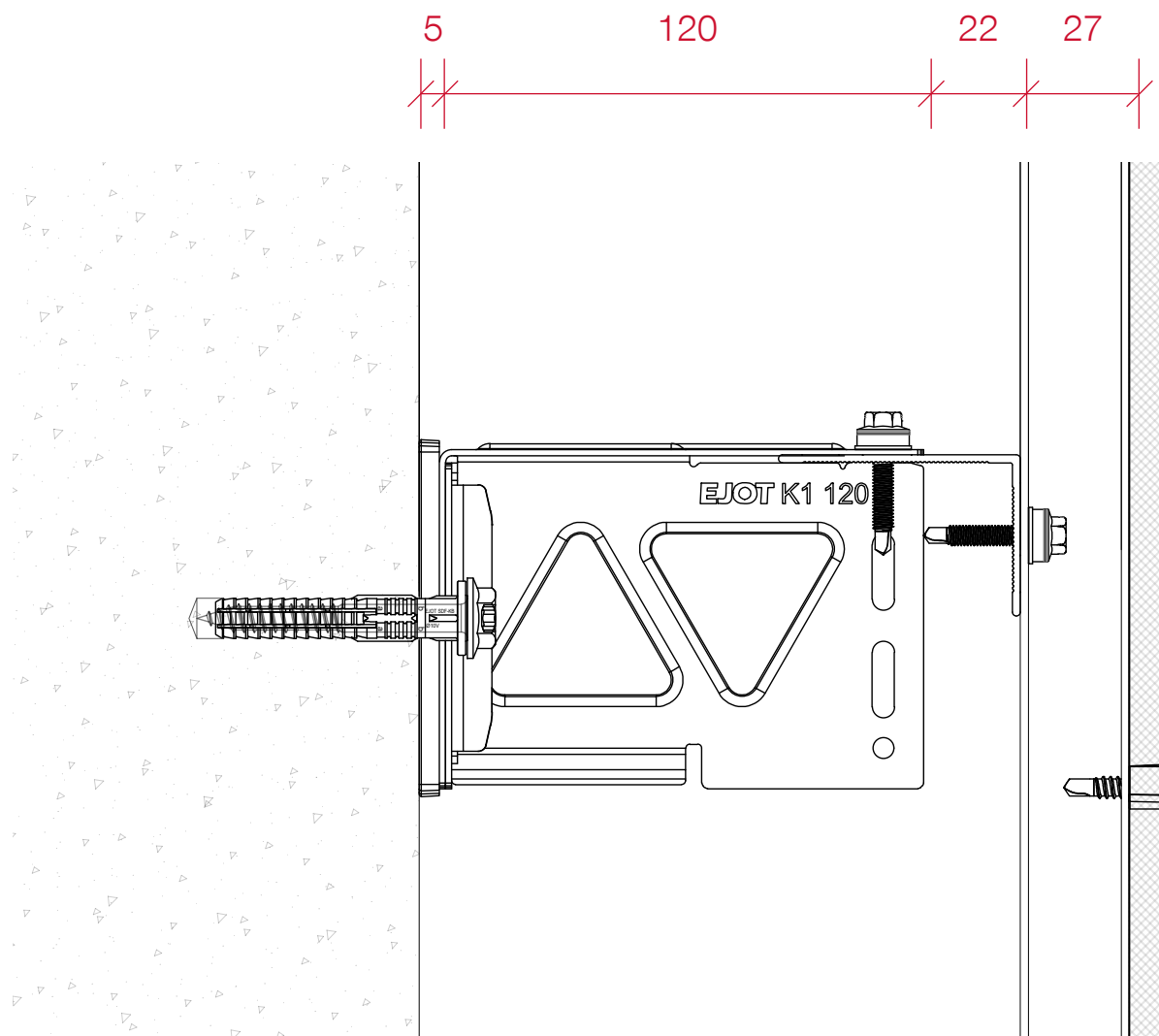



## Our service range

Your satisfaction comes first

**With the EJOT CROSSFIX® system we offer you a complete facade substructure from a single supplier. You provide all the information about your project and we will develop the right solution for you.**

In addition to our complete range of services, which you can view on the Internet, we offer you the following optional services specifically for your CROSS-FIX® project:

- > Preparation of an offer for the square meter price of the regular surface on the basis of the completed checklist and the documents provided
- > Initial sizing and a reference surface based on it
- > Dowel pull-out tests on masonry on site by trained EJOT specialists
- > U-value calculation

# We are committed

EJOT® is a member of various trade associations and organisations



Fachverband Baustoffe und Bauteile für vorgehängte hinterlüftete Fassaden e. V.  
www.fvhf.de



Deutscher Schraubenverband e. V.  
www.schraubenverband.de



Verband Fenster + Fassade  
www.window.de



Fachverband Werkzeugindustrie e. V.  
www.werkzeug.org



ift Rosenheim, Institut für Fenstertechnik e. V.  
www.ift-rosenheim.de



Institut Bauen und Umwelt e. V.  
www.bau-umwelt.de



Industrierverband für Bausysteme im Metalleichtbau e. V.  
www.ifbs.de



Global Fastener Alliance®  
www.globalfasteneralliance.com



Warenzeichenverband Edelstahl Rostfrei e. V.  
www.wzv-rostoffrei.de



Verband für Dämmsysteme, Putz und Mörtel e. V.  
www.vdpm.info



www.ppa-europe.eu



www.mcrma.co.uk



Österreichischer Fachverband für hinterlüftete Fassaden  
www.oefhf.at



Mitglied im Bundesverband Solarwirtschaft e. V.  
www.solarwirtschaft.de



Schweizerischer Fachverband für hinterlüftete Fassaden  
www.sfhf.ch



Europäischer Fachverband für Wärmedämm-Verbundsysteme  
www.ea-etics.eu



ARGE Qualitätsgruppe Wärmedämmsysteme  
www.waermedaemmsysteme.at



Österreichische Arbeitsgemeinschaft Putz  
www.oep.at



Stifterverband für die Deutsche Wissenschaft e. V.  
www.stifterverband.org



BuGG Bundesverband GebäudeGrün e. V.  
www.gebaeudegruen.info/



[www.ejot.com/construction](http://www.ejot.com/construction)

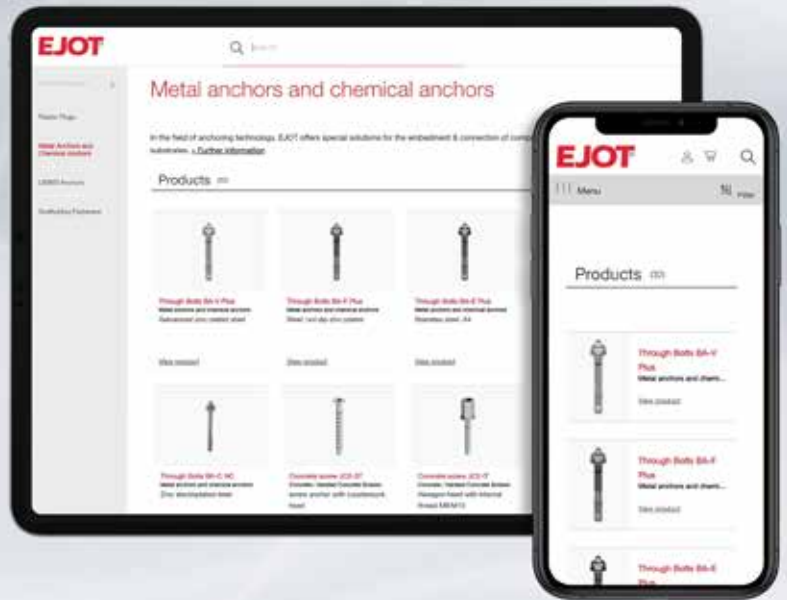

# The fastest way to the appropriate EJOT® product

## Discover EJOT Worldwide

EJOT is an European market leader in fastening technology. In Europe, our numerous sales companies and offices guarantee direct customer contact and fast availability of our products. EJOT services and products are also available on an international scale. We have production sites and sales offices in North America and Asia.

Find your contact person for all EJOT distribution and production companies and our partner and sales offices – worldwide. We look forward to hearing from you.



**EJOT Worldwide:**  
[www.ejot.com/construction](http://www.ejot.com/construction)



# The International EJOT® Group

The origin is in Germany, the future in the world

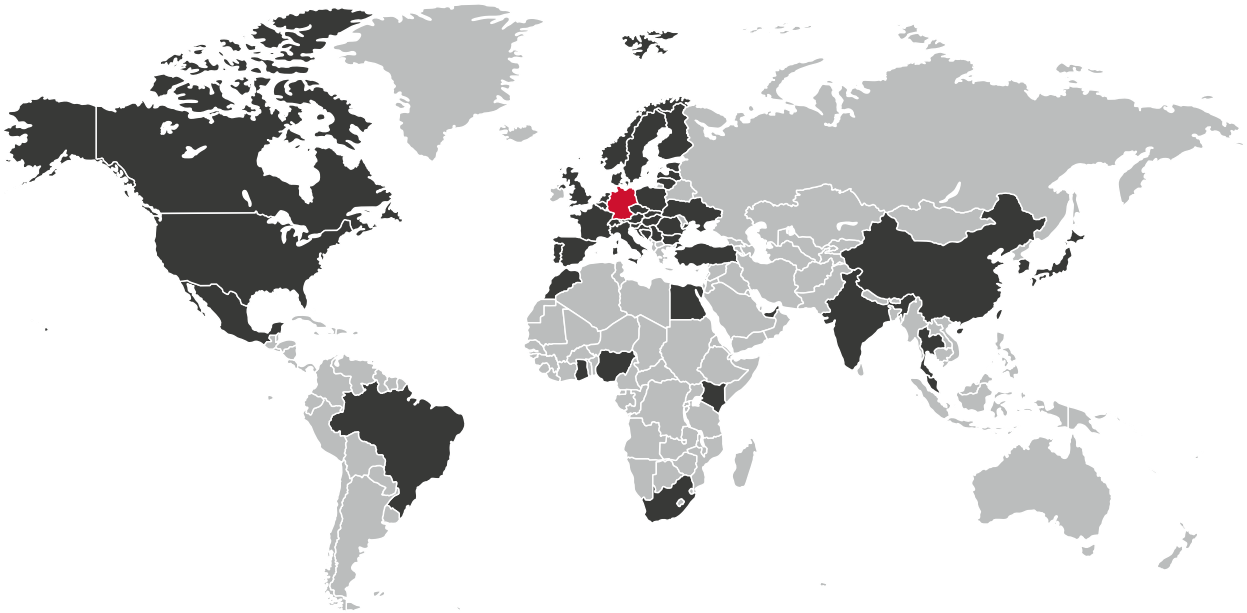

## Locations worldwide

[www.ejot.com/subsidiary\\_selector](http://www.ejot.com/subsidiary_selector)



Find your contact for all EJOT sales and production companies as well as our partner and sales offices - worldwide. We are looking forward to hearing from you.



**46 million**  
Screws

In our manufacturing plants around the world, we produce up to 46 million items for construction and industry every day.



**36,000**  
Products

Screws, anchors, through bolts or complex part groups – the EJOT portfolio is made up of around 36,000 products.



**2,100**  
Patents

Our engineers are constantly developing new product solutions that are protected by 2,100 patents.



**1922**  
founded

The history of EJOT dates back to the early 20th century.



**3,700**  
Employees

More than 3,700 employees work for our worldwide customers every day.

ENGINEERED IN

**GERMANY**

The majority of the EJOT portfolio is produced in Germany and developed by our own R&D department.

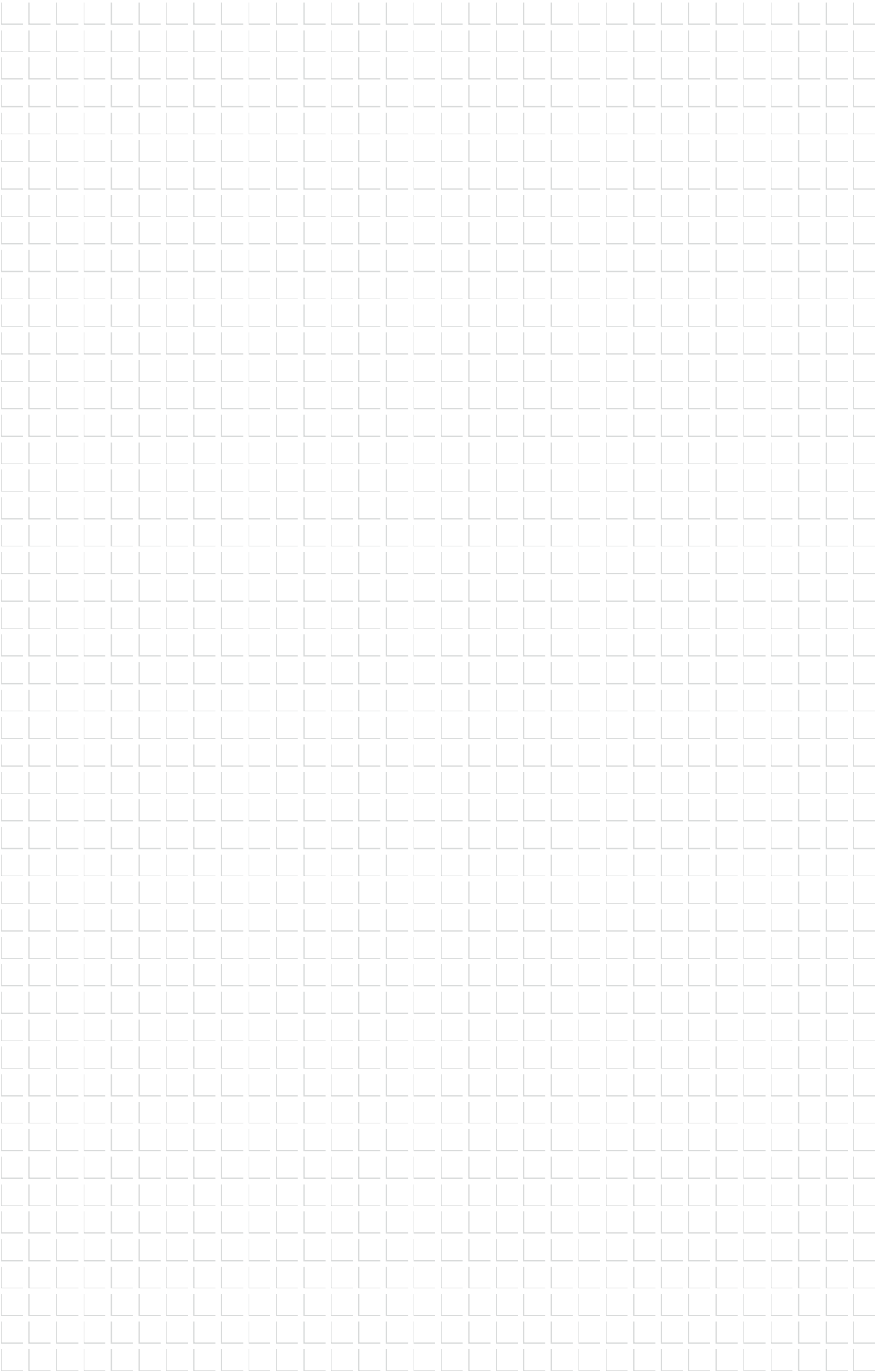

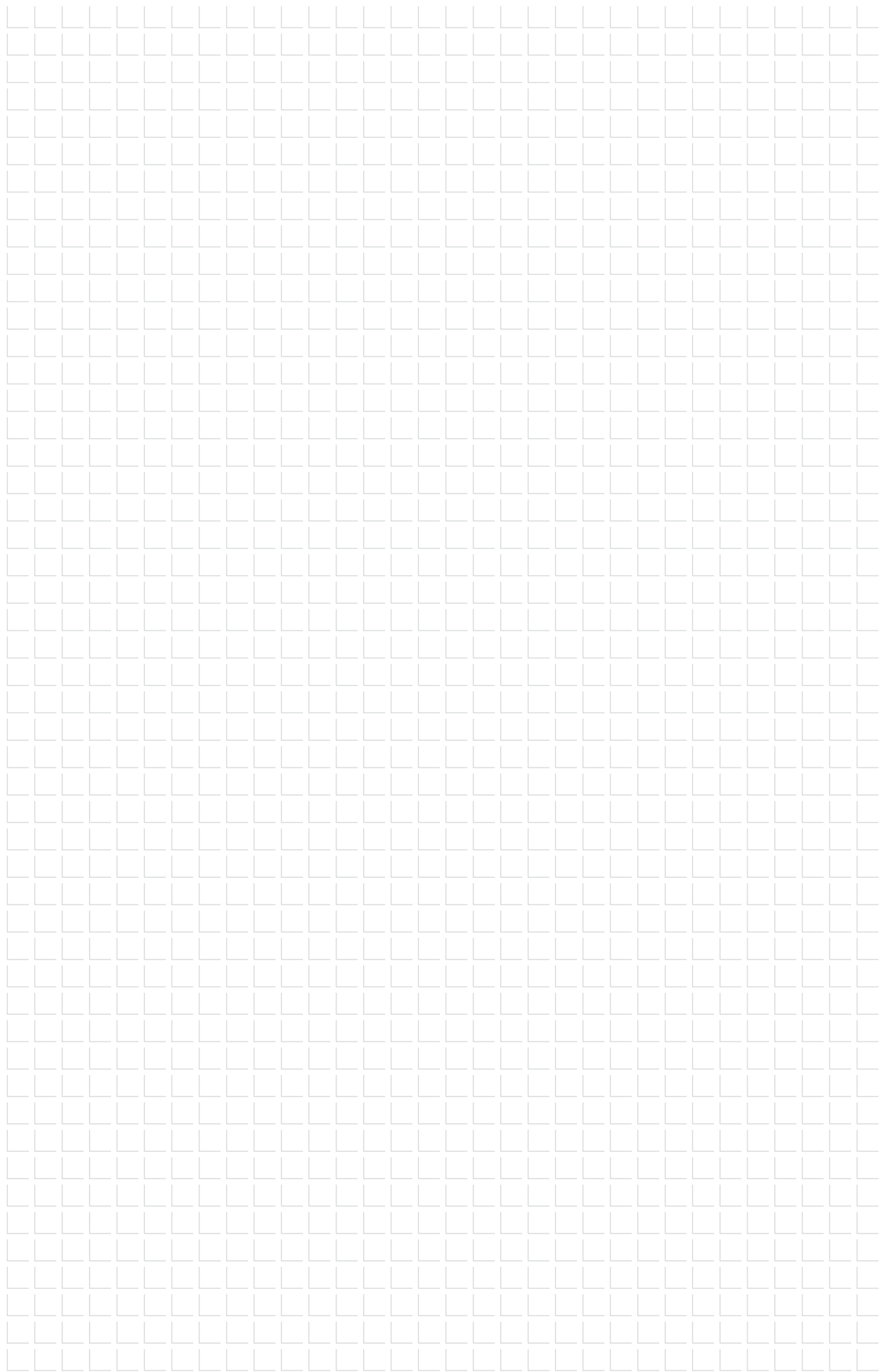

**EJOT SE & Co. KG**

**Market Unit Construction**

In der Stockwiese 35

57334 Bad Laasphe · Germany

T +49 2752 908-0

F +49 2752 908-731

construction@ejot.com

www.ejot.com/construction



Bringing it together.